

Le train du manège descend.

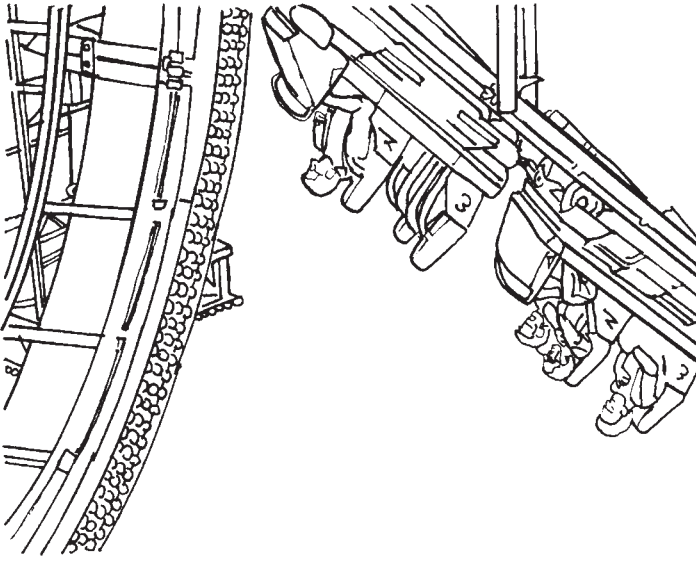

La voiture monte.

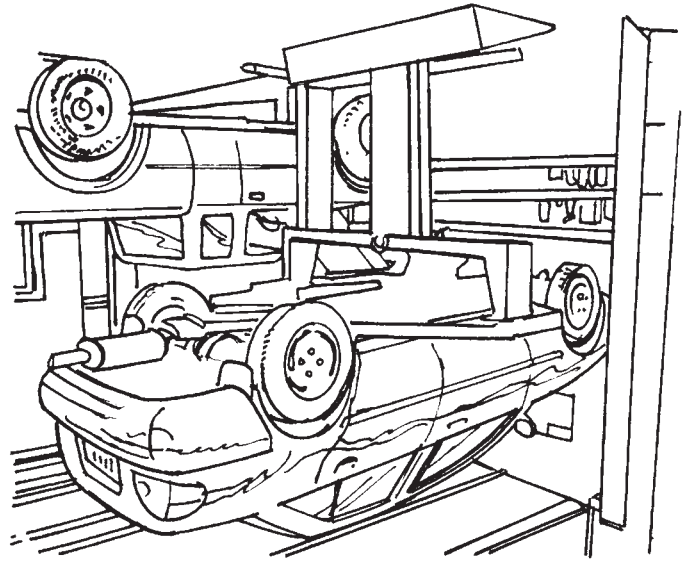

A

© Scholastic Canada Ltd., 2009 En haut, en bas 978-0-7791-8846-8

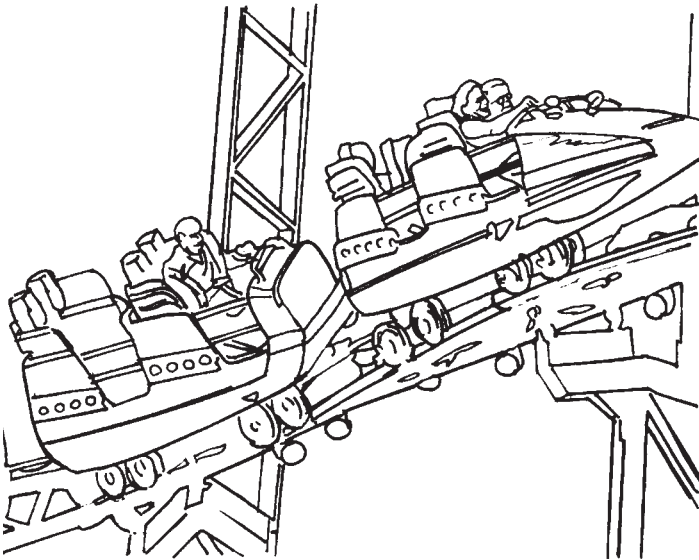

Le train du manège monte.

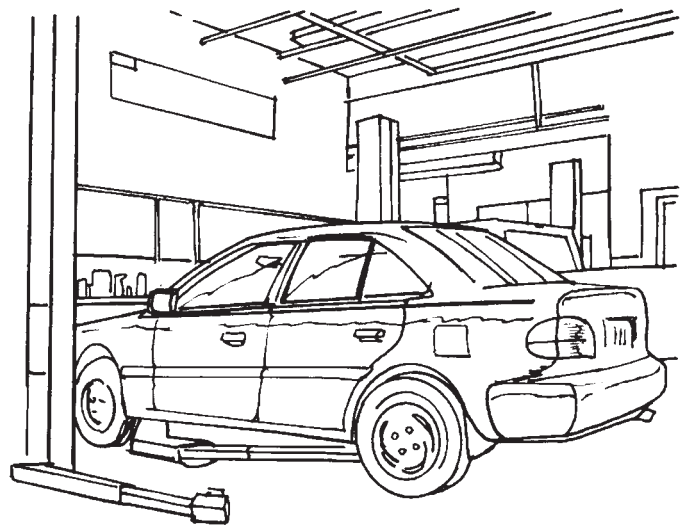

La voiture descend.

Le garçon descend.

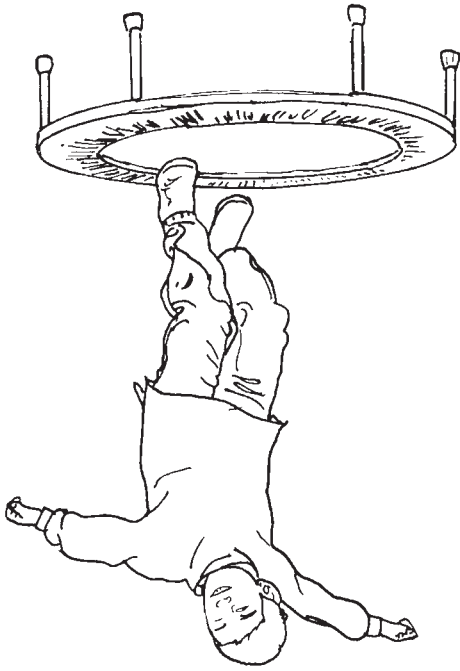

Le garçon monte.

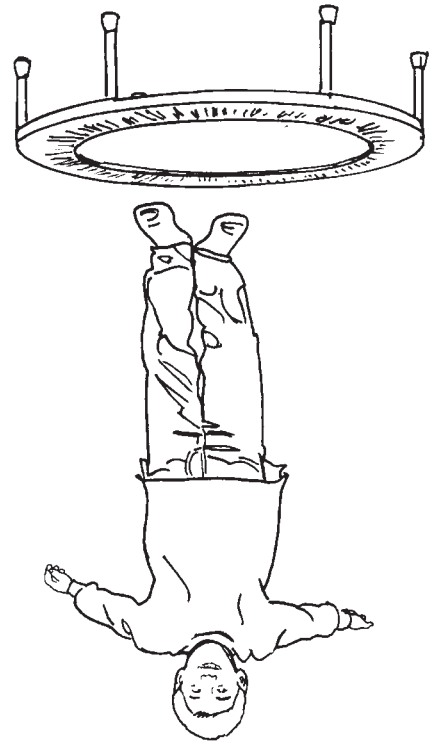

© Scholastic Canada Ltd., 2009 En haut, en bas 978-0-7791-8846-8

B

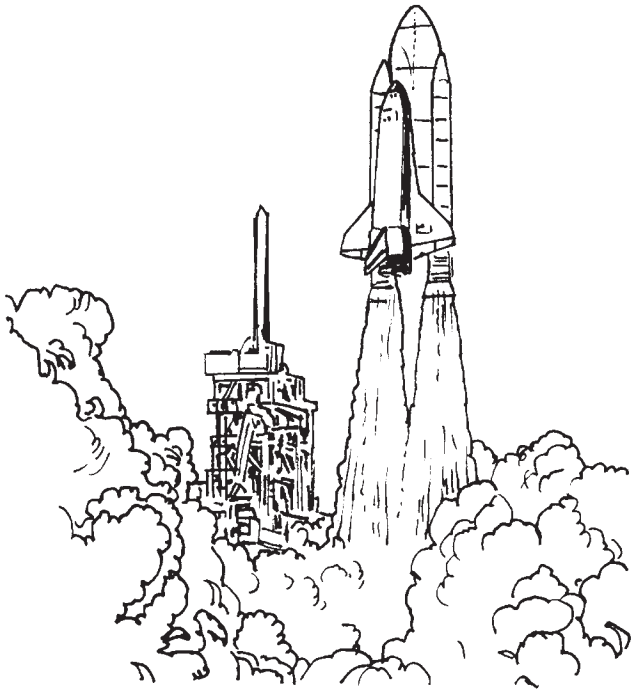

La navette spatiale monte.

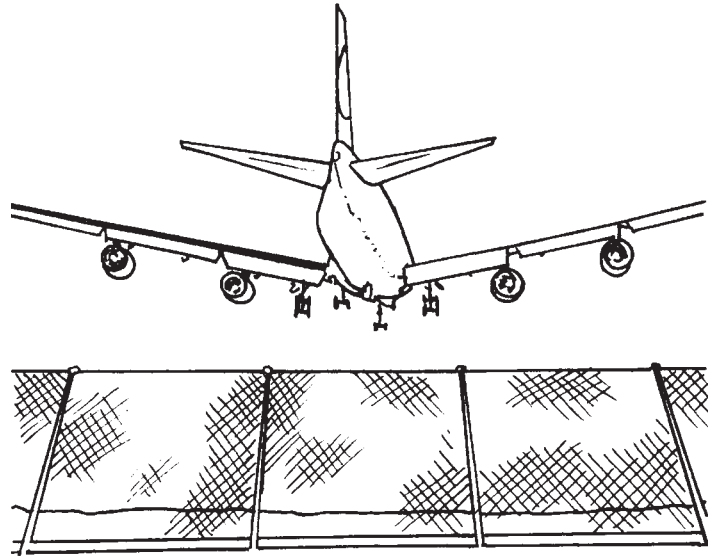

L'avion descend.

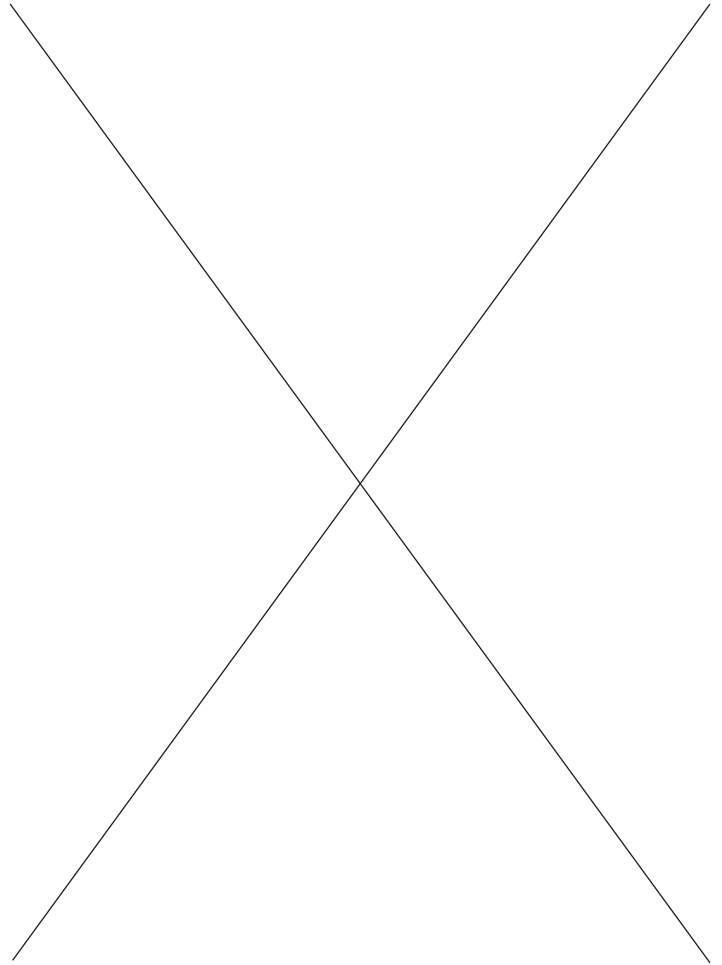
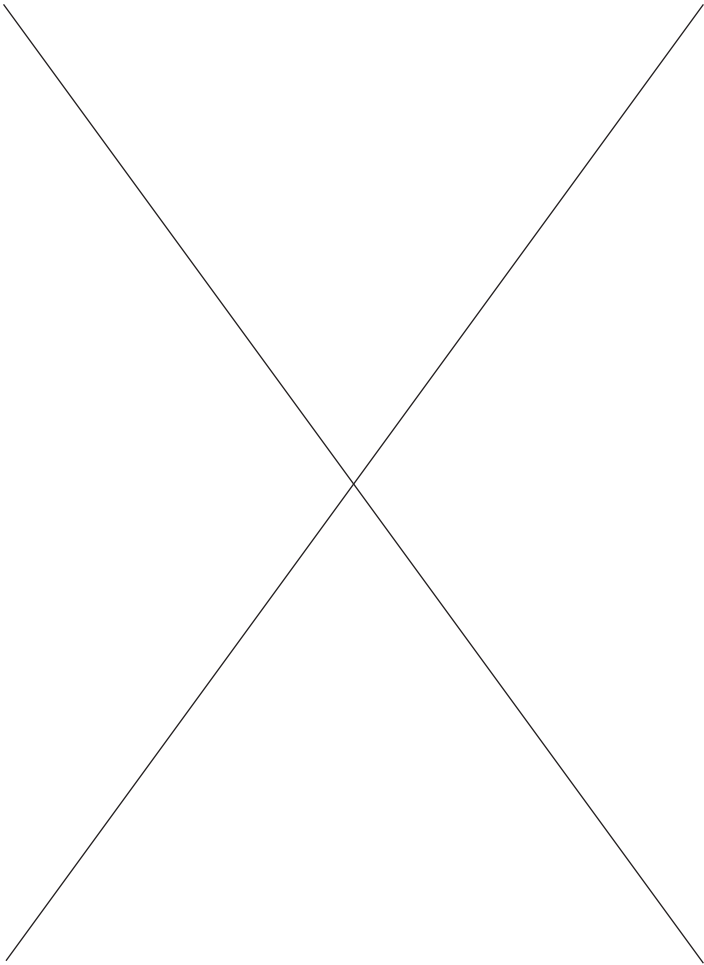

C

© Scholastic Canada Ltd., 2009 En haut, en bas 978-0-7791-8846-8 

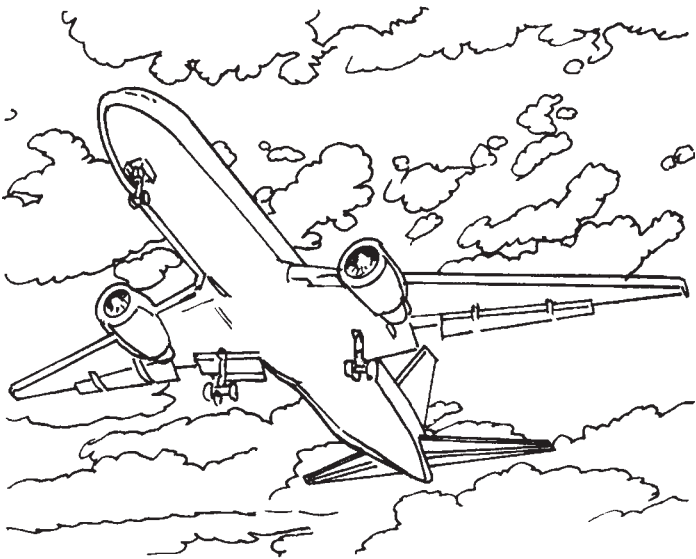

L'avion monte.

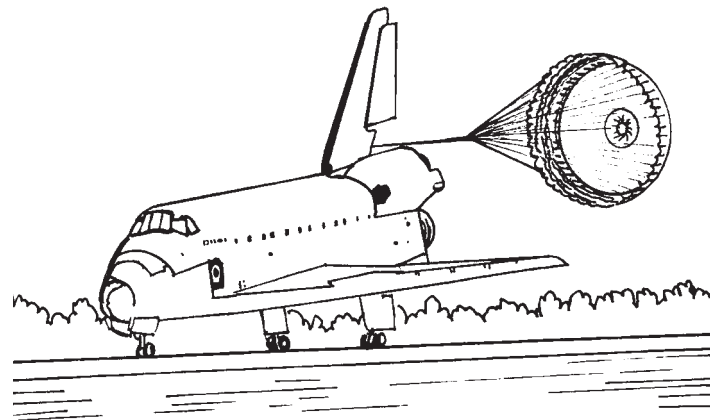

La navette spatiale descend.

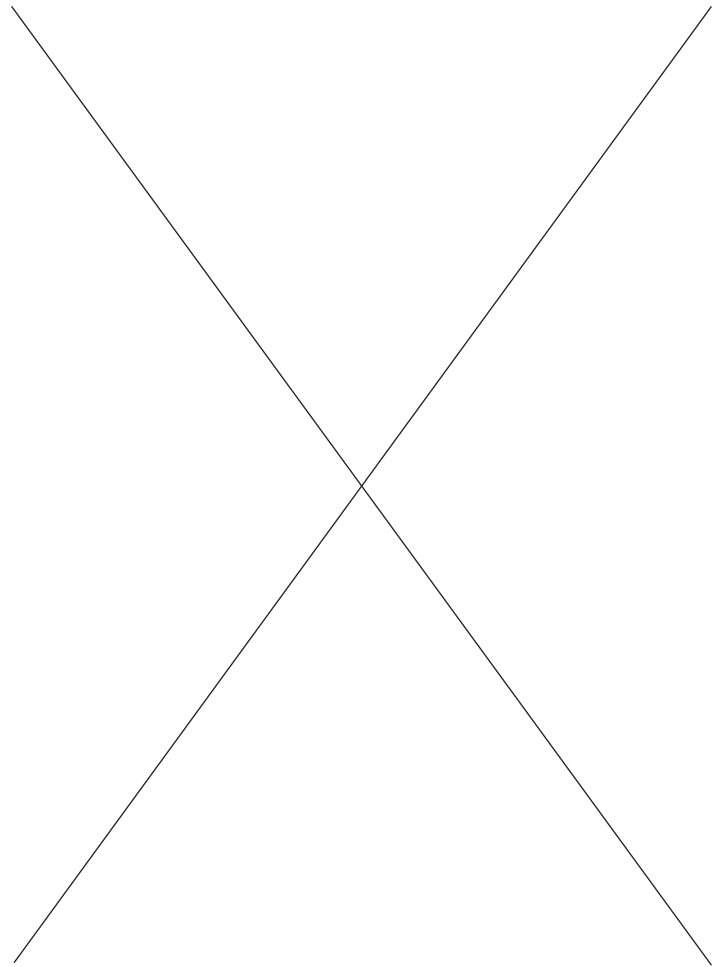
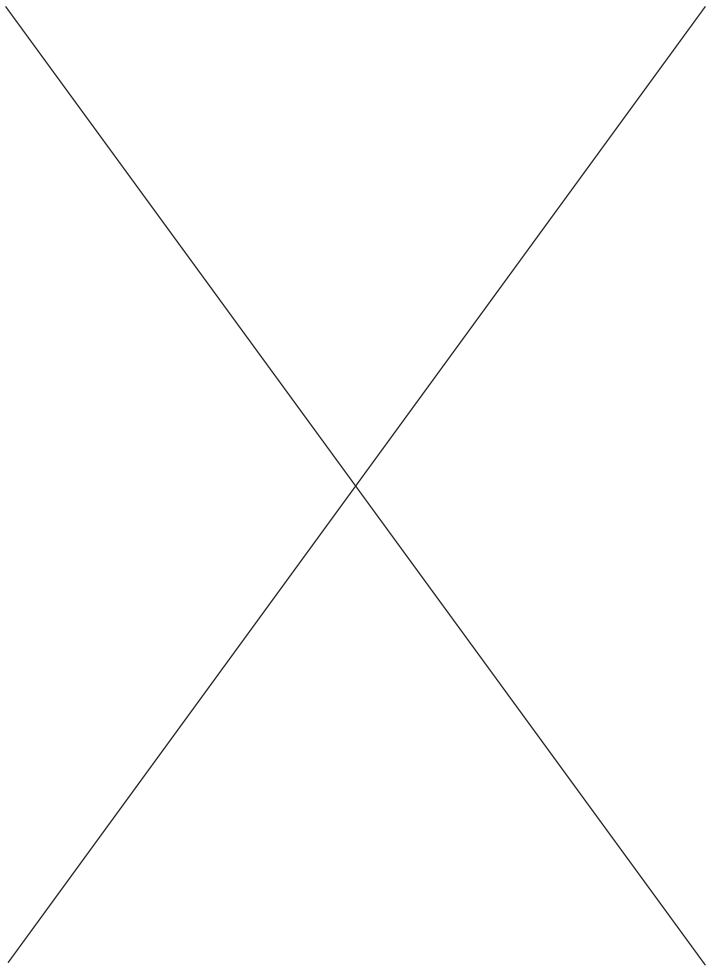

D 



# En haut, en bas



Texte de  
Nicholas Kouncar  
Texte français de  
Solange Champagne

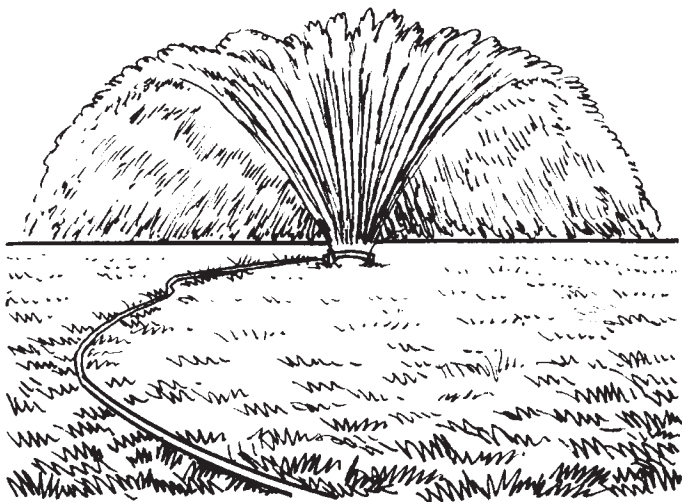

© Scholastic Canada Ltd., 2009. En haut, en bas 978-0-7791-8846-8

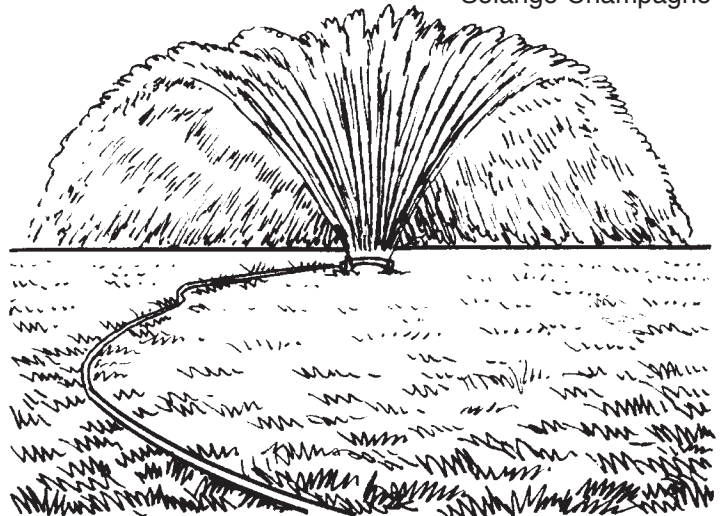

L'eau monte et l'eau  
descend.